

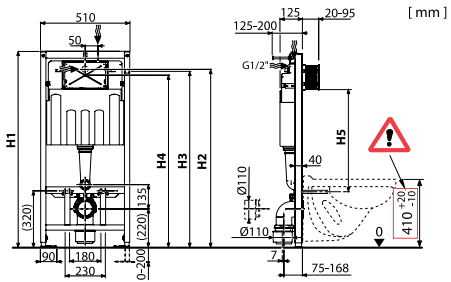

AM101/850 ■ AM101/1000 ■ AM101/1120
AM101/1120E ■ AM101/1120V

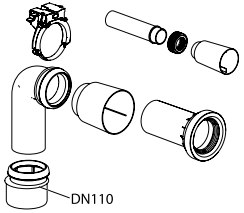

	H1	H2	H3	H4	H5
AM101/850	866	820	800	780	390
AM101/1000	980	935	915	895	490
AM101/1120	1120	1020	1000	980	590
AM101/1120E					
AM101/1120V					

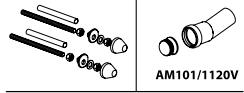
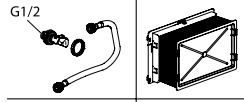
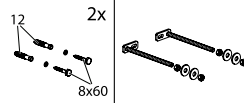
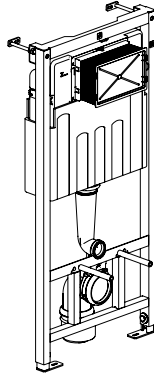
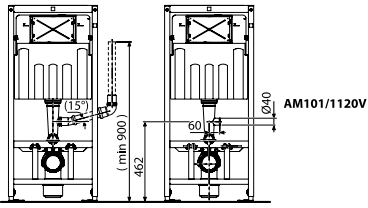

1

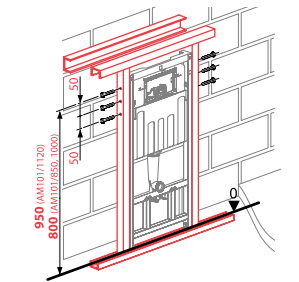
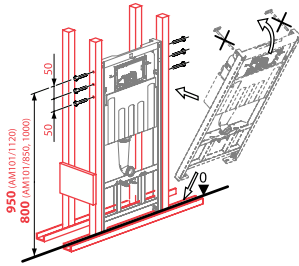
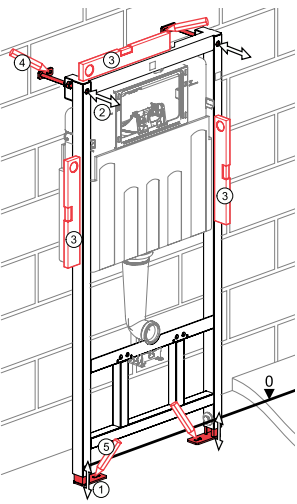

2

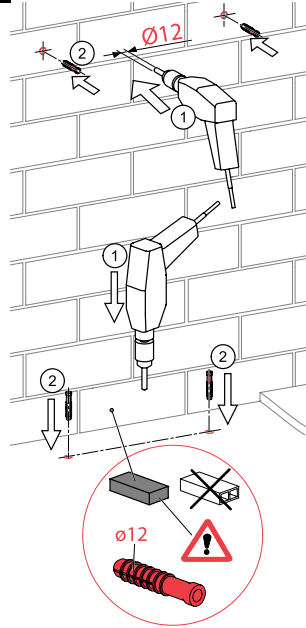

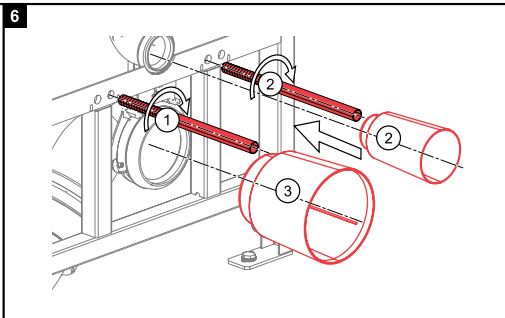
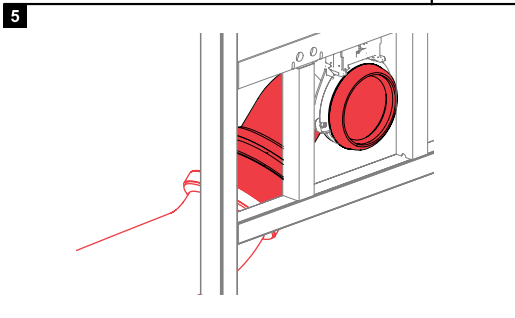
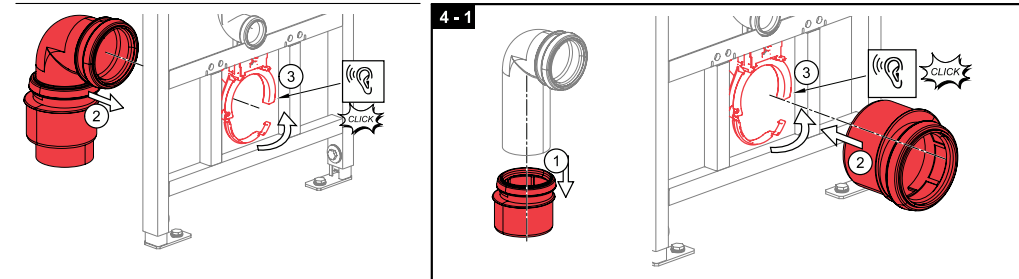
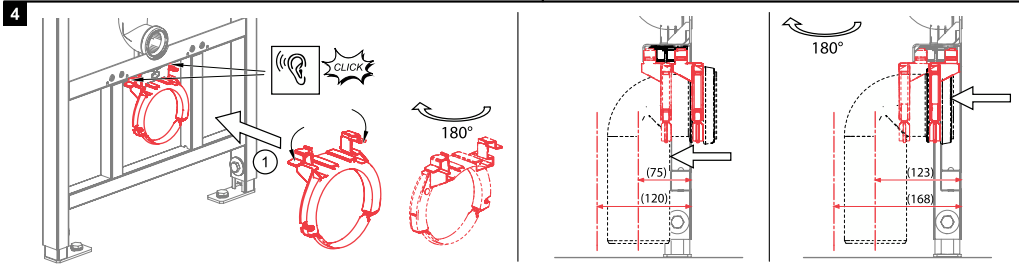
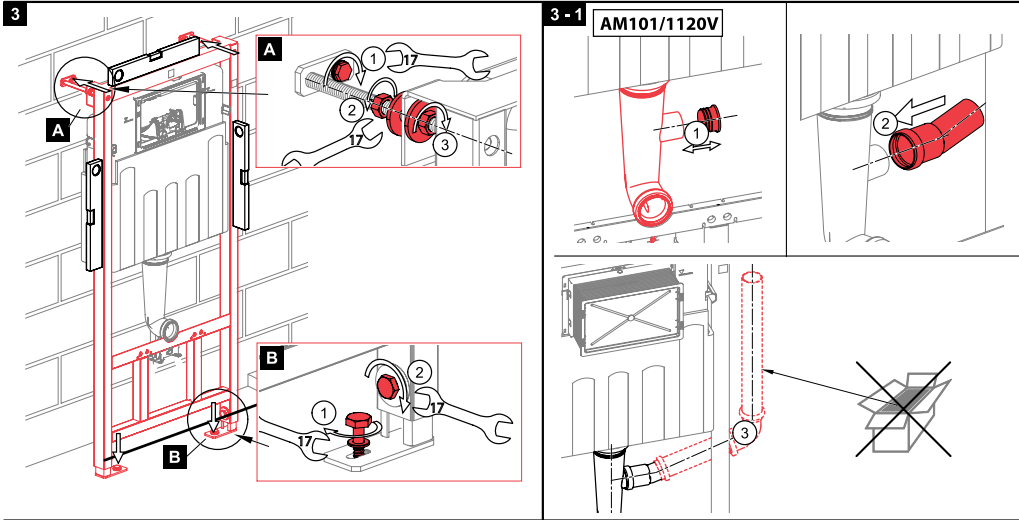

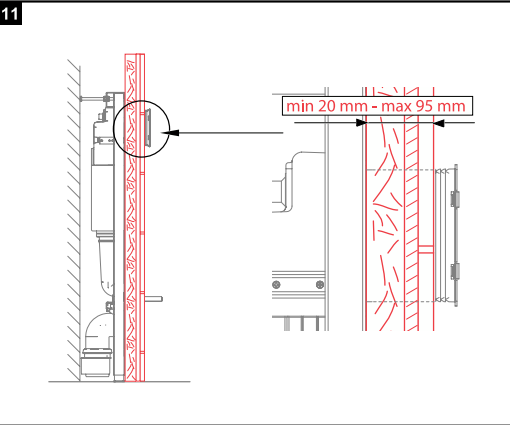
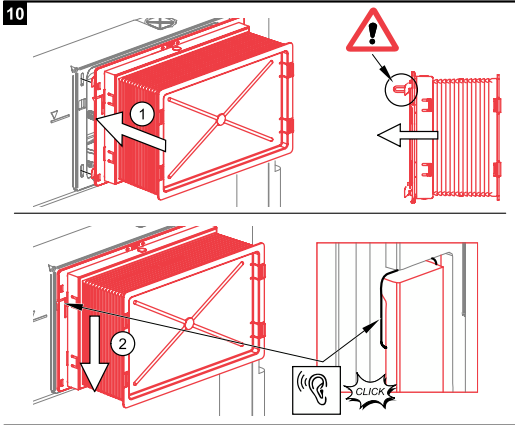
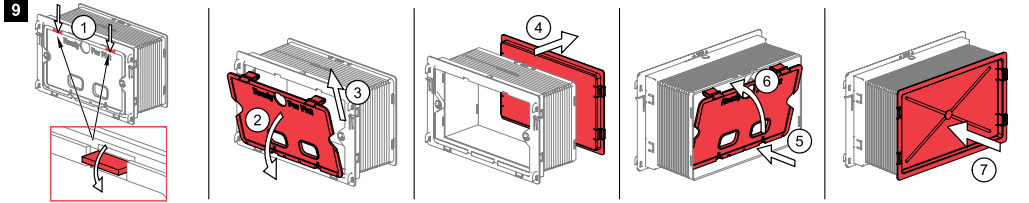
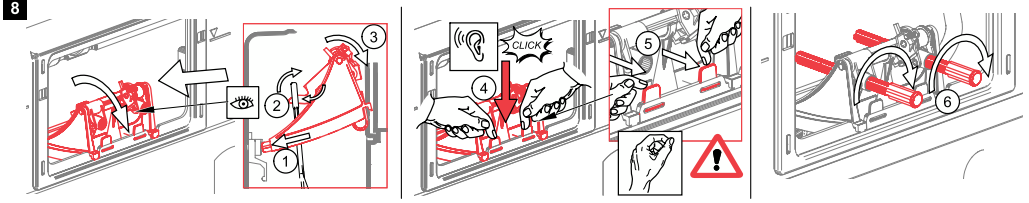
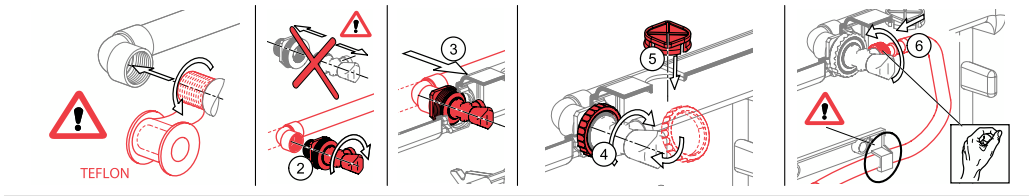
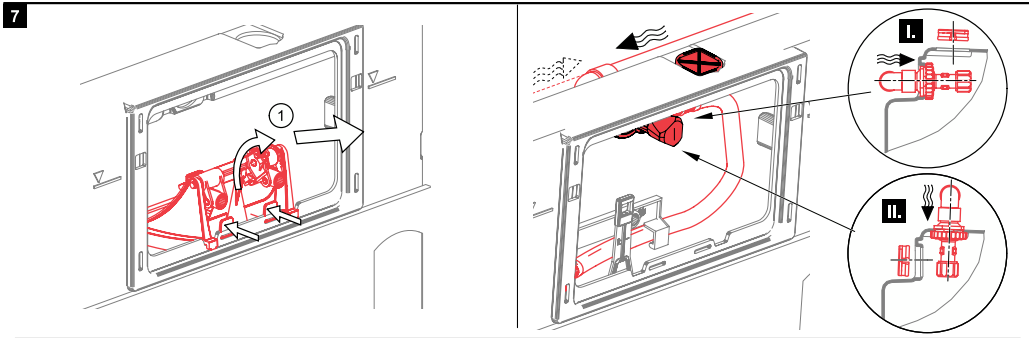

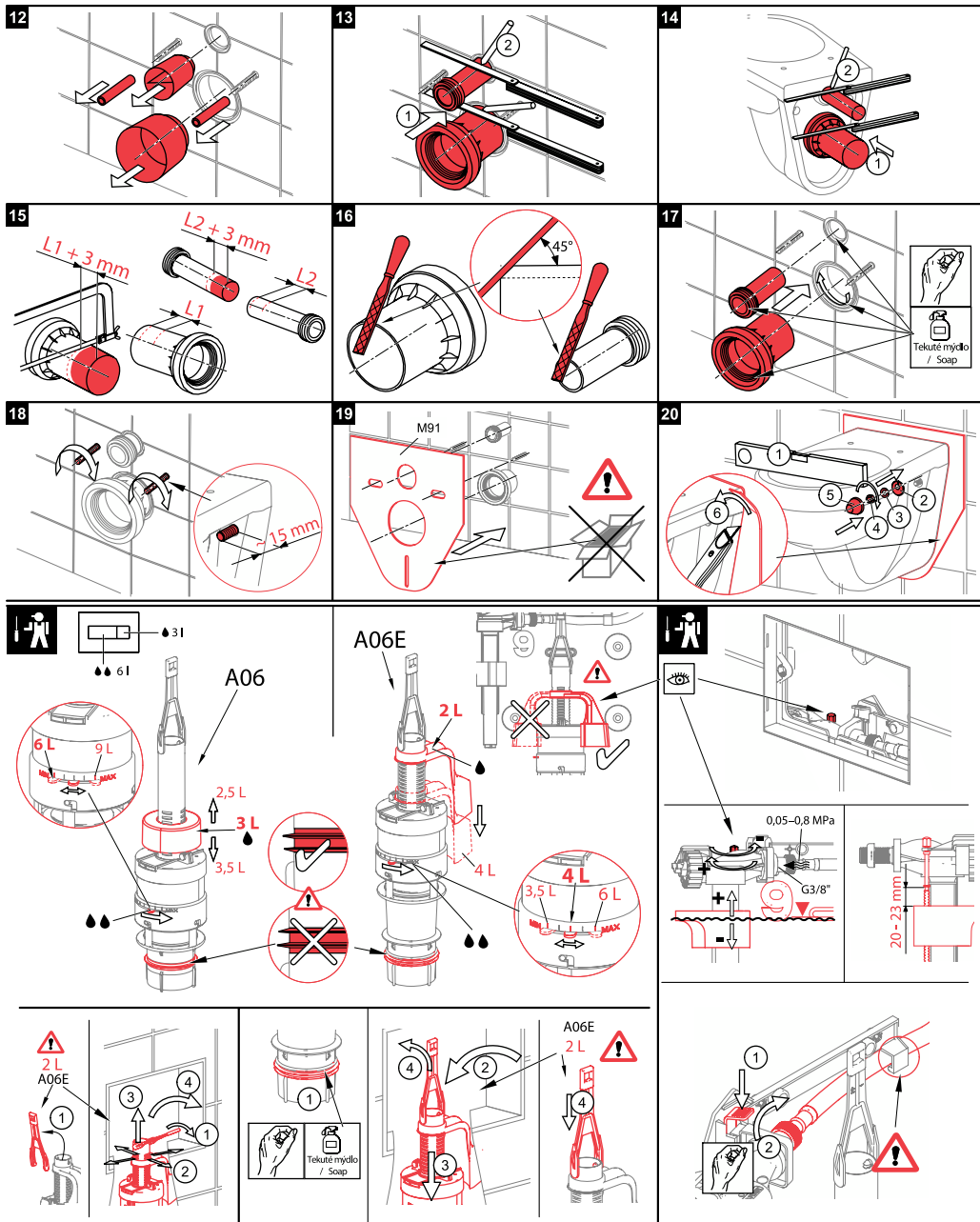

Alca plast, s. r. o.
 Bratislavská 2846, 690 02 Břeclav, Česká republika
 Tel.: +420 519 821 117 – prodej ČR
 Tel.: +420 519 821 041 – export, Fax: +420 519 821 083
 e-mail: alcaplast@alcaplast.cz, www.alcaplast.cz
 © 2017 Alcaplast, s.r.o.