



VOGA II

620 1K

 minimal cabinet size

1 BOWL SINK

 inset sink

Index: **P_Z_097_10_0620**

 installation with mounting clips

LENGTH	WIDTH	HEIGHT
620	510	207

 cutting template included

 automatic siphon included

 possibility of a dishwasher connection

 possibility of installing a waste disposer

 available in wide colors range

 material: MAGRANIT®

 weight : 12.3 kg

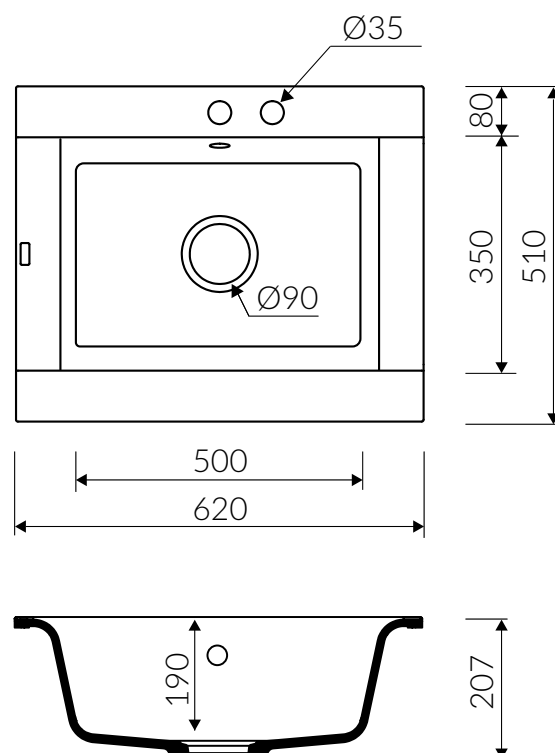

Dimensions of the kitchen sink may differ by 0.3 %.

